

ARL-3014UEUGW/3L (3009R1G6D-FHC)



Features

- Hi-Eff Red and Yellow Green chips are matched for uniform light output
- Common Cathode
- T-1 type package
- Long life solid state reliability
- Low power consumption
- Pb free
- The product itself will remain within RoHS compliant Version.

Description

- The lamp contain two integral chips and is available bicolor
- The Red and Yellow Green light is emitted by diodes of GaAsP/ GaP and GaP respectively
- White Diffused lens color

Application

- TV set
- Monitor
- Telephone
- Computer
- Circuit board

Package Dimensions

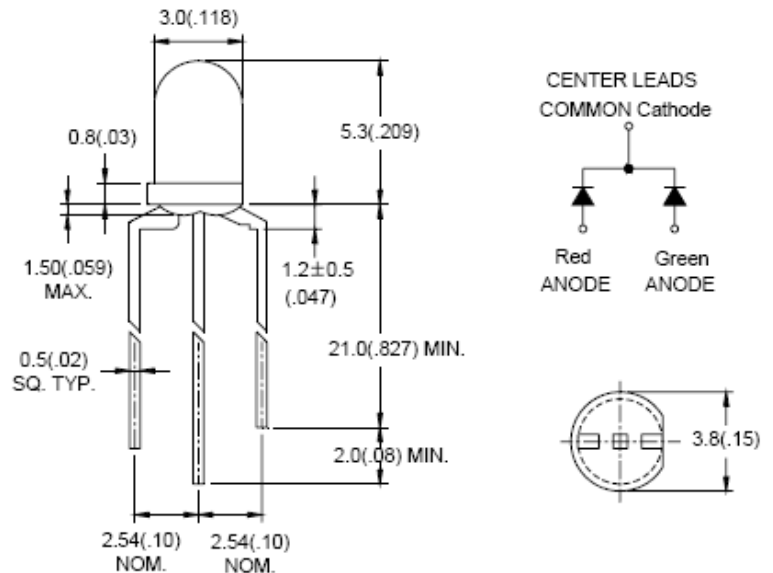

1. Other dimensions are in millimeters, tolerance is 0.25mm except being specified
2. Protruded resin under flange is 1.5mm Max LED
3. Bare copper alloy is exposed at tie-bar portion after cutting

Part No.	Chip		Lens Color
	Material	Emitted Color	
ARL-3014UEUGW/3L (3009R1G6D-FHC)	AlGaInP	Red	Diffused
	GaAsP/GaP	Green	

Notes

1. Surge will damage the LED
2. When using LED, it must use a protective resistor in series with DC current about 18mA

Absolute Maximum Rating at Ta=25°C

Parameter	Symbol	Value	Units
Forward Pulse Current	I_{FPM}	70	mA
Forward Current	I_{FM}	30	mA
Reverse Voltage	V_R	5	V
Power Dissipation	P_D	140	mW
Operating Temperature	T_{opr}	-40~+80	°C
Storage Temperature	T_{stg}	-40~+100	°C
Soldering Heat (5s)	T_{sol}	260	°C

Typical optical characteristics curves

Relative Intensity VS. Wavelength

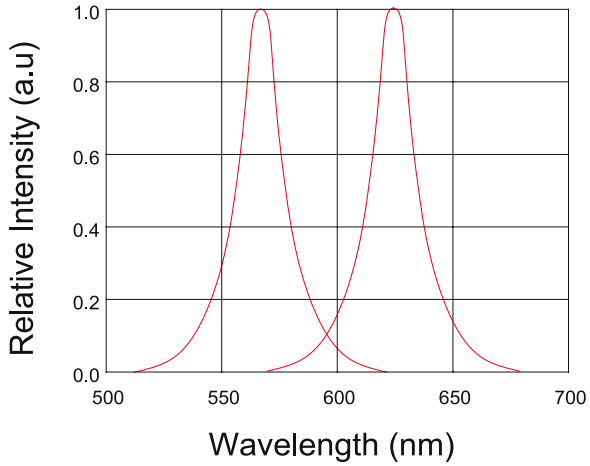

Forward Current VS. Forward Voltage

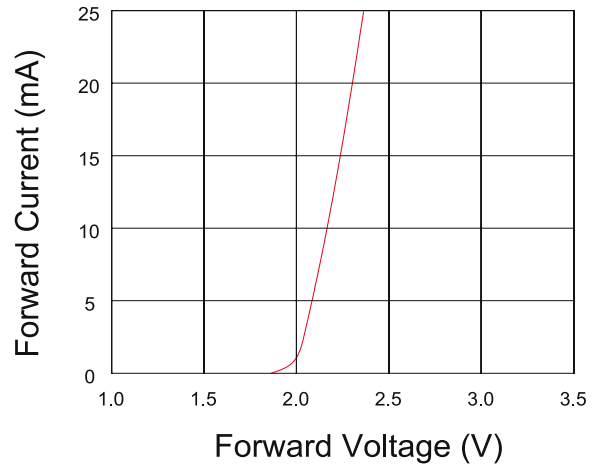

Relative Intensity VS. Ambient Temp

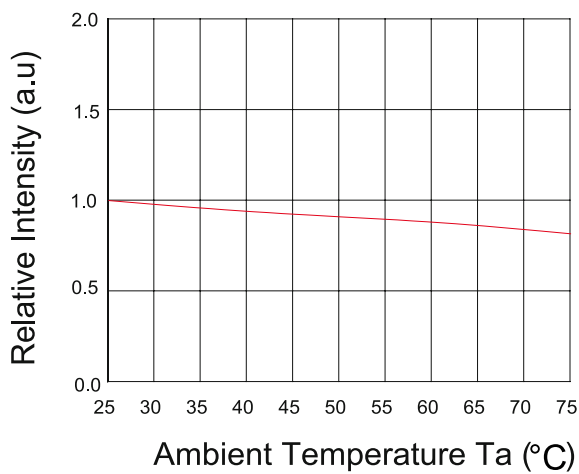

Forward Current VS. Relative Intensity

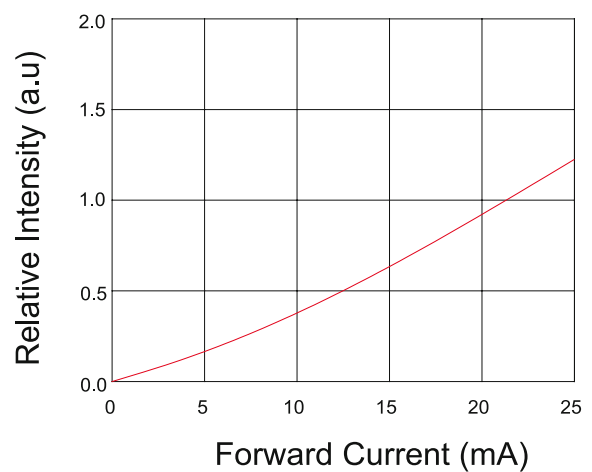

Forward Current VS. Ambient Temp.

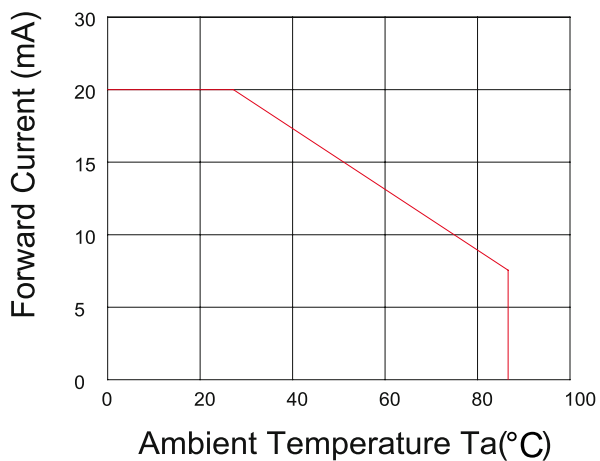

Radiation Characteristics

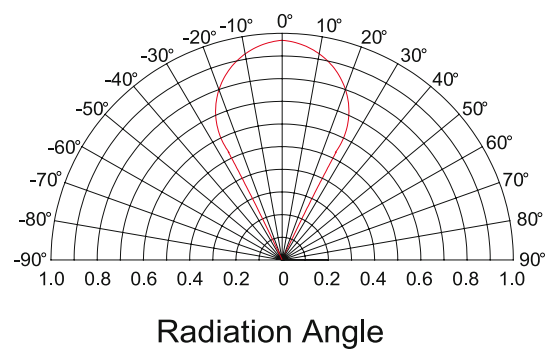

Electrical / Optical Characteristics at Ta=25°C

Parameter	Symbol	Device	Min.	Typ.	Max	Units	Test Conditions
Luminous Intensity	I _v	Red	400	500	700	mcd	IF=20mA
		Green	100	150	250		
Viewing Angle	2θ _{1/2}	Red	--	30	--	Deg	(Note 1)
		Green					
Peak Emission Wavelength	λ _p	Red	620	630	635	nm	IF=20mA
		Green	565	570	575		
Spectral Line Half-Width	Δλ	Red	15	20	25	nm	IF=20mA
		Green	15	20	25		
Forward Voltage	V _F	Red	1.9	--	2.3	V	IF=20mA
		Green	1.9	--	2.4		
Reverse Current	I _R	Red	--	--	10	μA	VR=5V
		Green	--	--			